

# MM3Z2V4C-MM3Z75VC

## Zener Diodes

### Features

- Wide Zener Voltage Range Selection, 2.4V to 75V
- VZ Tolerance Selection of  $\pm 5\%$  (C Series)
- Very Small and Thin SMD package
- Clip Bonding Construction, Good Thermal Capability
- Matte Tin(Sn) finish, Pb Free



SOD-323F

### Connection Diagram

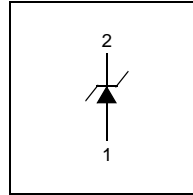

### Absolute Maximum Ratings T<sub>a</sub> = 25°C unless otherwise noted

Symbol	Parameter	Value	Units
P <sub>D</sub>	Power Dissipation	200	mW
T <sub>STG</sub>	Storage Temperature Range	-65 to +150	°C
T <sub>J</sub>	Maximum Junction Temperature	150	°C
I <sub>ZM</sub>	Maximum Regulator Current	P <sub>D</sub> /V <sub>Z</sub>	mA

\* These ratings are limiting values above which the serviceability of the diode may be impaired.

### Thermal Characteristics

Symbol	Parameter	Value	Unit
R <sub>θJA</sub>	Thermal Resistance, Junction to Ambient	595	°C/W

\* Device mounted on PCB with minimum land pad.

### Electrical Characteristics T<sub>amb</sub> = 25°C unless otherwise specified

Symbol	Parameter/ Test condition	Min.	Typ.	Max.	Unit
V <sub>F</sub>	Forward Voltage / I <sub>F</sub> =10 mA	--	--	1.0	V

### Package Marking and Ordering Information

Device Marking	Device	Package	Packing	Reel Size	Tape Width	Quantity
Refer to Product table list	Refer to Product table list	SOD-323F	Tape & Reel	7'	12mm	3,000

## Electrical Characteristics T<sub>A</sub>=25°C unless otherwise noted

Device Type	Device Marking	V <sub>Z</sub> (V) @ I <sub>ZT</sub>			Z <sub>ZT</sub> (Ω) @ I <sub>ZT</sub>	I <sub>ZT</sub> (mA)	Z <sub>ZK</sub> (Ω) @ I <sub>ZK</sub>	I <sub>ZK</sub> (mA)	I <sub>R</sub> (μA) @ V <sub>R</sub>	V <sub>R</sub> (V)
		Min.	Typ.	Max.	Max.	-	Max.	-	Max	-
MM3Z2V4C	Z0	2.28	2.4	2.52	94	5	564	1	45	1
MM3Z2V7C	Z1	2.57	2.7	2.84	94	5	564	1	18	1
MM3Z3V0C	Z2	2.85	3	3.15	89	5	564	1	9	1
MM3Z3V3C	Z3	3.14	3.3	3.47	89	5	564	1	4.5	1
MM3Z3V6C	Z4	3.42	3.6	3.78	84	5	564	1	4.5	1
MM3Z3V9C	Z5	3.71	3.9	4.1	84	5	564	1	2.7	1
MM3Z4V3C	Z6	4.09	4.3	4.52	84	5	564	1	2.7	1
MM3Z4V7C	Z7	4.47	4.7	4.94	75	5	470	1	2.7	2
MM3Z5V1C	Z8	4.85	5.1	5.36	56	5	451	1	1.8	2
MM3Z5V6C	Z9	5.32	5.6	5.88	37	5	376	1	0.9	2
MM3Z6V2C	ZA	5.89	6.2	6.51	9	5	141	1	2.7	4
MM3Z6V8C	ZB	6.46	6.8	7.14	14	5	75	1	1.8	4
MM3Z7V5C	ZC	7.11	7.5	7.86	14	5	75	1	0.9	5
MM3Z8V2C	ZD	7.79	8.2	8.61	14	5	75	1	0.63	5
MM3Z9V1C	ZE	8.65	9.1	9.56	14	5	94	1	0.45	6
MM3Z10VC	ZF	9.5	10	10.5	18	5	141	1	0.18	7
MM3Z11VC	ZG	10.45	11	11.55	18	5	141	1	0.09	8
MM3Z12VC	ZH	11.4	12	12.6	23	5	141	1	0.09	8
MM3Z13VC	ZJ	12.35	13	13.65	28	5	160	1	0.09	8
MM3Z15VC	ZK	14.25	15	15.75	28	5	188	1	0.045	10.5
MM3Z16VC	ZL	15.2	16	16.8	37	5	188	1	0.045	11.2
MM3Z18VC	ZM	17.1	18	18.9	42	5	212	1	0.045	12.6
MM3Z20VC	ZN	19	20	21	51	5	212	1	0.045	14
MM3Z22VC	ZP	20.9	22	23.1	51	5	235	1	0.045	15.4
MM3Z24VC	ZR	22.8	24	25.2	65	5	235	1	0.045	16.8
MM3Z27VC	ZS	25.65	27	28.35	75	5	282	0.5	0.045	18.9
MM3Z30VC	ZT	28.5	30	31.5	75	5	282	0.5	0.045	21
MM3Z33VC	ZU	31.35	33	34.65	75	5	306	0.5	0.045	23
MM3Z36VC	ZV	34.2	36	37.8	84	5	329	0.5	0.045	25.2
MM3Z39VC	ZW	37.05	39	40.95	122	5	329	0.5	0.045	27.3
MM3Z43VC	ZX	40.85	43	45.15	141	5	353	0.5	0.045	30.1
MM3Z47VC	ZY	44.65	47	49.35	160	5	353	0.5	0.045	33
MM3Z51VC	Z-	48.45	51	53.55	169	5	376	0.5	0.045	35.7
MM3Z56VC	Z=	53.2	56	58.8	188	5	400	0.5	0.045	39.2
MM3Z62VC	Z≡	58.9	62	65.1	202	5	423	0.5	0.045	43.4
MM3Z68VC	Z>	64.6	68	71.4	226	5	447	0.5	0.045	47.6
MM3Z75VC	Z<	71.25	75	78.75	240	5	470	0.5	0.045	52.5

## Notes :

1. The Zener Voltage (V<sub>Z</sub>) is tested under pulse condition of 10mS.
2. The device numbers listed have a standard tolerance on the nominal zener voltage of ±5%.
3. The zener impedance is derived from the 60-cycle ac voltage, which results when an ac current having an rms value equal to 10% of the dc zener current (I<sub>ZT</sub> or I<sub>ZK</sub>) is superimposed to I<sub>ZT</sub> or I<sub>ZK</sub>.

## Typical Performance Characteristics

Figure 1. Zener current vs. Zener Voltage

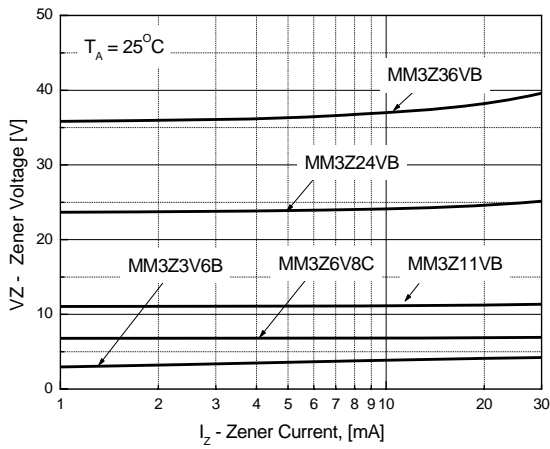

Figure 2. Zener current vs. Zener Impedance

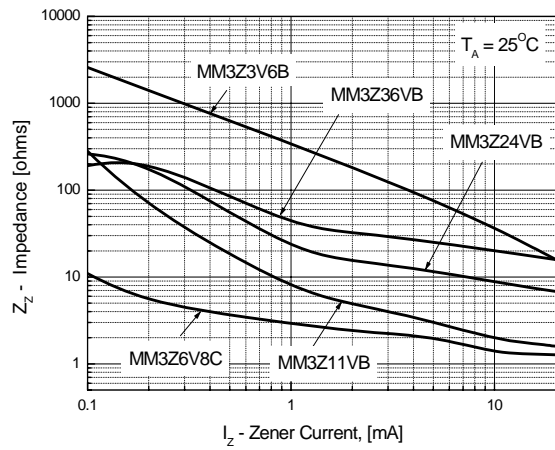

Figure 3. MM3Z3V6B  
Zener current vs. Zener Voltage

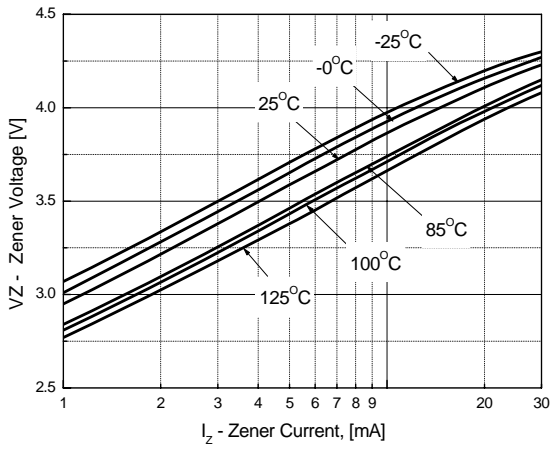

Figure 4. MM3Z6V8C  
Zener current vs. Zener Voltage

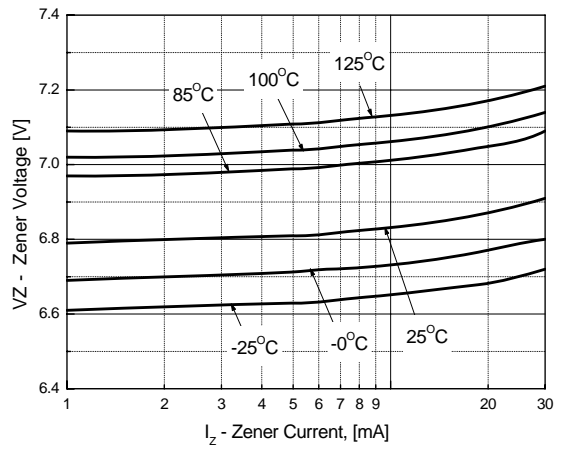

Figure 5. MM3Z11VB  
Zener current vs. Zener Voltage

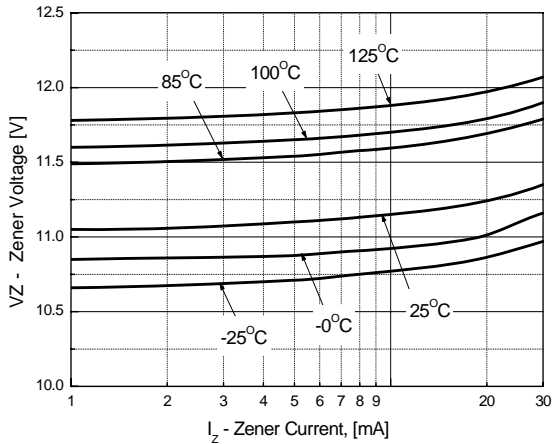
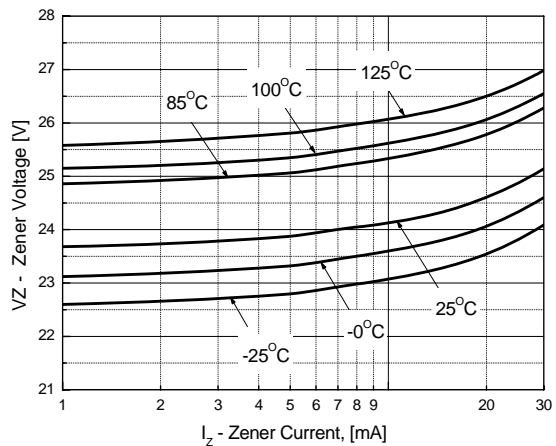
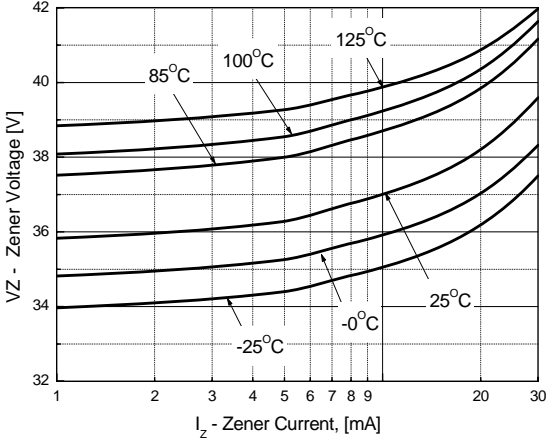

Figure 6. MM3Z24VB  
Zener current vs. Zener Voltage



Typical Performance Characteristics

Figure 7. MM3Z36VB  
Zener current vs. Zener Voltage



# Package Dimensions

## SOD - 323F

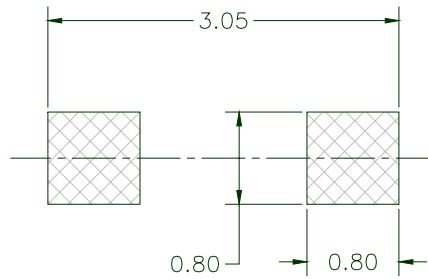
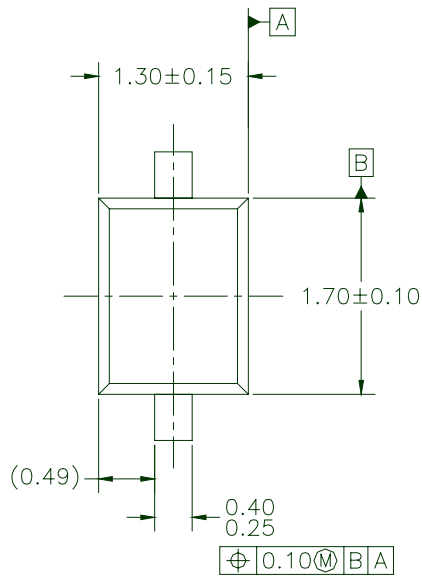

LAND PATTERN RECOMMENDATION

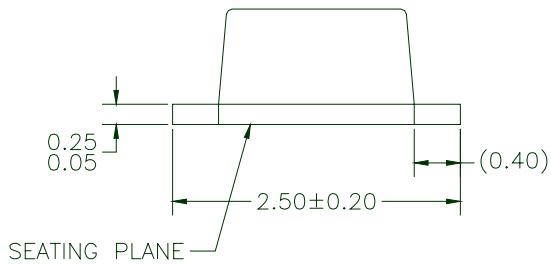

NOTES: UNLESS OTHERWISE SPECIFIED

- A) THIS PACKAGE IS COMPLIANT TO JEITA SC90 STANDARD EXCEPT FOR THE OVERALL PACKAGE HEIGHT.
- B) ALL DIMENSIONS ARE IN MILLIMETERS.
- C) DIMENSIONS ARE EXCLUSIVE OF BURRS, MOLD FLASH AND TIE BAR EXTRUSIONS.
- D) DIMENSIONING AND TOLERANCING PER ASME Y14.5M - 1994.



## TRADEMARKS

The following are registered and unregistered trademarks Fairchild Semiconductor owns or is authorized to use and is not intended to be an exhaustive list of all such trademarks.

ACE <sup>x</sup> ™	GTO™	PowerSaver™	TinyBuck™
Across the board. Around the world.™	HiSeC™	PowerTrench®	TinyLogic®
ActiveArray™	<i>i-Lo</i> ™	Programmable Active Droop™	TINYOPTO™
Bottomless™	ImpliedDisconnect™	QFET®	TinyPower™
Build it Now™	IntelliMAX™	QS™	TinyWire™
CoolFET™	ISOPLANAR™	QT Optoelectronics™	TruTranslation™
CROSSVOLT™	MICROCOUPLER™	Quiet Series™	μSerDes™
CTL™	MicroPak™	RapidConfigure™	UHC®
<i>Current Transfer Logic</i> ™	MICROWIRE™	RapidConnect™	UniFET™
DOME™	MSX™	ScalarPump™	VCX™
E <sup>2</sup> CMOS™	MSXPro™	SMART START™	Wire™
EcoSPARK®	OCX™	SPM™	
EnSigna™	OCXPro™	SuperFET™	
FACT Quiet Series™	OPTOLOGIC®	SuperSOT™-3	
FACT®	OPTOPLANAR™®	SuperSOT™-6	
FAST®	PACMAN™	SuperSOT™-8	
FAST <sub>r</sub> ™	POP™	TCM™	
FPS™	Power220®	The Power Franchise®	
FRFET™	Power247®	TinyBoost™	
GlobalOptoisolator™	PowerEdge™		

## DISCLAIMER

FAIRCHILD SEMICONDUCTOR RESERVES THE RIGHT TO MAKE CHANGES WITHOUT FURTHER NOTICE TO ANY PRODUCTS HEREIN TO IMPROVE RELIABILITY, FUNCTION OR DESIGN. FAIRCHILD DOES NOT ASSUME ANY LIABILITY ARISING OUT OF THE APPLICATION OR USE OF ANY PRODUCT OR CIRCUIT DESCRIBED HEREIN; NEITHER DOES IT CONVEY ANY LICENSE UNDER ITS PATENT RIGHTS, NOR THE RIGHTS OF OTHERS. THESE SPECIFICATIONS DO NOT EXPAND THE TERMS OF FAIRCHILD'S WORLDWIDE TERMS AND CONDITIONS, SPECIFICALLY THE WARRANTY THEREIN, WHICH COVERS THESE PRODUCTS.

## LIFE SUPPORT POLICY

FAIRCHILD'S PRODUCTS ARE NOT AUTHORIZED FOR USE AS CRITICAL COMPONENTS IN LIFE SUPPORT DEVICES OR SYSTEMS WITHOUT THE EXPRESS WRITTEN APPROVAL OF FAIRCHILD SEMICONDUCTOR CORPORATION.

As used herein:

1. Life support devices or systems are devices or systems which, (a) are intended for surgical implant into the body, or (b) support or sustain life, or (c) whose failure to perform when properly used in accordance with instructions for use provided in the labeling, can be reasonably expected to result in significant injury to the user.

2. A critical component is any component of a life support device or system whose failure to perform can be reasonably expected to cause the failure of the life support device or system, or to affect its safety or effectiveness.

## PRODUCT STATUS DEFINITIONS

### Definition of Terms

Datasheet Identification	Product Status	Definition
Advance Information	Formative or In Design	This datasheet contains the design specifications for product development. Specifications may change in any manner without notice.
Preliminary	First Production	This datasheet contains preliminary data, and supplementary data will be published at a later date. Fairchild Semiconductor reserves the right to make changes at any time without notice in order to improve design.
No Identification Needed	Full Production	This datasheet contains final specifications. Fairchild Semiconductor reserves the right to make changes at any time without notice in order to improve design.
Obsolete	Not In Production	This datasheet contains specifications on a product that has been discontinued by Fairchild semiconductor. The datasheet is printed for reference information only.

Rev. I23